



Job Name: _____

Type: _____

Part #: _____

Notes: _____

DESCRIPTION

Mini-electrical inverter systems for powering up to 220 Watts/250VA of incandescent, fluorescent, induction or LED lighting loads. Pulse width modulated (PWM) output design provides clean, 60 Hz. sinusoidal emergency power to loads. Models are available for surface, recessed or T-Grid mounting as required.

FEATURES

- For powering Incandescent, fluorescent, induction and LED fixtures *
 - Sinusoidal output eliminates compatibility problems
 - Universal 120/277VAC, 60Hz. input/output
 - Unit capacities up to 220W/250VA
 - "Soft Start" design reduces fixture inrush current
 - Unit may be installed up to 1,000 feet from controlled fixture(s)
 - Surface, recessed or T-Grid mount models
 - Lumen output from fixture is 100% of nominal
 - Unique design eliminates compatibility problems with LED drivers as well as fluorescent and induction ballasts
 - Compatible with dimming ballasts
 - Normally-on and/or Normally-off load output
 - Provisions for local switching capability - Always on during emergency conditions regardless of local switch position
 - Emergency fixtures can be on, off or switched
 - Solid state, line latched low voltage disconnect provides protection against battery deep discharge
 - Long life, maintenance-free lead-calcium battery
 - Momentary test switch
 - AC-On, Charge-On and Inverter-On LED indicators
 - Meets NFPA Life Safety Code 101, OSHA, NEC, State and local Codes
 - UL 924 listed
 - Optional T-Grid models are plenum rated
- * Consult factory for compatibility for other lamp types



ORDERING GUIDE

Model Number	Input/Output Volts	Capacity For 1 1/2 Hrs.		Battery Voltage (VDC)	System Weight*	
		Watts	VA		(Lbs.)	(Kg.)
SPS-55/125	120/277	55	125	24	32	14
SPS-110/125	120/277	110	125	24	38	17
SPS-110/250	120/277	110	250	48	47	21
SPS-220/250	120/277	220	250	48	60	27

* System weights shown include installed batteries

SYSTEM OPTIONS (1)(2)

Suffix	Description
-S	Surface Mount Housing
-R	Recess Mount Housing (3)
-T	Plenum Rated Ceiling T-Grid Mount Housing (3)
-SP	Special Housing Color (Specify)
-4C	4 Output Circuit Switching

(1) Other options available. Consult factory.

(2) Some options may impact product UL listing. Consult factory.

(3) Available with SPS-55/125 and SPS-110/125 models only.

DIMENSIONS

Standard Surface Mount Housings

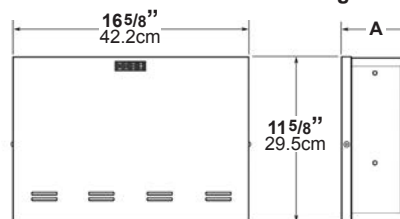

Models	Depth Dimension A"
SPS-55/125, SPS-110/125	4 1/4" (10.8cm)
SPS-110/250, SPS-220/250	6 1/4" (15.9cm)

Optional Recessed Mount Housing

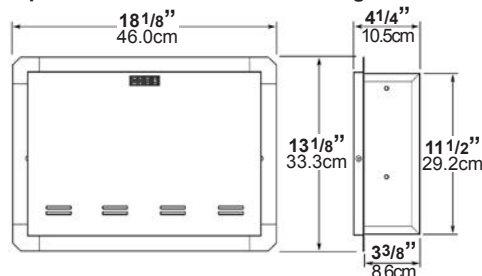

Optional Ceiling T-Grid Mount Housing

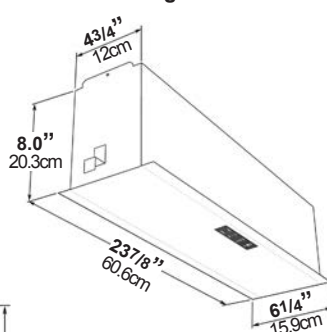



Job Name: _____

Type: _____

Part #: _____

Notes: _____

APPLICATION

The SPS Series is designed to provide up to 220 watts/250VA of emergency power to incandescent, fluorescent, induction and/or LED fixtures. The SPS unit provides clean, sinusoidal AC output power allowing it to be remotely mounted up to 1,000 feet away from the controlled fixture(s). Unlike a ballast fluorescent emergency pack, the SPS provides power to the input side of the fixture, (including the ballast) eliminating any chance of incompatibility. The SPS Series is designed primarily for surface mounting, however, the SPS-55/125 and SPS-110/125 models provide optional housings for recessed or ceiling T-Grid mounting if required. All SPS systems will provide emergency power output for a minimum of 90 minutes.

CONSTRUCTION

Housing: Heavy duty steel cabinet is finished in white baked-on powder paint providing scratch and corrosion resistance. Optional special color paint (-SP) finishes are available, consult factory.

MOUNTING

Surface Mount: (Standard Models)

Surface mount models are designed for mounting to walls by means of keyhole slots provided in the back of the unit housing.

Recess Mount: (SPS-55/125, SPS-110/125 Only):

Recess models provide recess mounting holes on both sides of the enclosure.

T-Grid Mount: (SPS-55/125, SPS-110/125 Only):

Housing design allows simple drop-in installation between t-grid runs. Safety wires (supplied by others) are required for attachment to building structure.

WIRING

Connection to an unswitched AC circuit is required by the NEC. Wiring access is provided for by conduit knockouts in the unit housing. SPS-55/125 and SPS-110/125 models also provide knockouts in the back of the housing for rear wiring from standard electrical boxes when surface mounting.

LOAD COMPATIBILITY

SPS model's clean, sinusoidal AC output will operate incandescent lamps as well as all common fluorescent, induction and LED lamp types. Consult factory for compatibility with all other lamp types. Lighting loads are driven at 100% output for the entire emergency power cycle. This outstanding feature translates into greater occupant egress vision and safety.



CODE INFORMATION

All models are UL924 Listed and meet NFPA 101 Life Safety Code, NEC, OSHA, Local and State Codes. Optional T-Grid models are plenum rated.

ELECTRICAL SPECIFICATIONS

Input

Input Voltages: (60Hz) 120 or 277VAC ± 10%

Input Frequencies: 60Hz ± 2%

Input Protection: AC Line Fuses

Output

Output Voltages: (60Hz) 120 or 277VAC

Efficiency Rating: 98% at full rated load (line)

Waveform: Sinusoidal (digitally controlled)

Static Voltage: ± 5% during battery discharge. 0-100% linear load.

Output Frequencies: 60 Hz. ± 0.3Hz during emergency cycle

Output Distortion: Less than 3% THD (linear load)

Transfer Time: Less than 1.0 second

Load Power Factor Range: 0.44 Lead to 0.44 Lag

Minimum Loading: 0% of rated system capacity

Output Protection: Line and inverter fuses

GENERAL SPECIFICATIONS

System Model Number	On-Line System Efficiency (Full Load)	Number Of Batteries	Battery Voltage (VDC)	Battery Current (Amps) (Max.)	AC Input Current		Thermal Output In BTUs	
					120VAC (Max.)	277VAC On-Line	Emergency	
SPS-55/125	98%	2	24	3.4	1.2	0.52	9	90
SPS-110/125	98%	2	24	5.7	1.2	0.52	9	95
SPS-110/250	98%	4	48	3.3	2.4	1.1	18	163
SPS-220/250	98%	4	48	5.6	2.4	1.1	18	167



Job Name: _____

Type: _____

Part #: _____

Notes: _____

BATTERIES AND CHARGER

Battery

Battery: Sealed Lead Calcium (10 year life)

Battery Voltage: 24VDC for SPS-55/125, SPS-110/125 models and 48VDC for SPS110/250, SPS220/250 models

Runtime: 90 minutes standard - based on battery performance at 77°F (25°C).

Other runtimes available, consult factory.

Battery Protection: Low Voltage Battery Disconnect protects the battery from being severely damaged by deep discharge during prolonged power failures.

DC Overload and Short Circuit Protection provided by a DC input breaker and fuse.

Charger

Charger Type: Fully automatic, temperature compensated, dual-mode charger

Power Consumption (Charger Only):
15W maximum (2.5W in standby) for SPS-55/125, and SPS-110/125 models
30W maximum (5W in standby) for SPS110/250, and SPS220/250 models

Recharge Duty Cycle: Meets UL924 requirements

Battery Circuit Breaker: Also used as battery isolator

Controls: Momentary test switch, AC-On, Charge-On and Inverter-On LED indicator lights

Safety Circuitry: AC Lockout prevents battery discharge prior to initial unit power-up. Brownout Protection automatically switches the unit to emergency mode when utility voltage is significantly reduced.

Environmental

Altitude: < 10,000 feet (3,000m) above sea level without derating.

Operating Temperature Range: 68°F to 86°F (20°C to 30°C)

NOTE: Optimum system performance between 20°C (68°F) and 30°C (86°F); temperatures outside of this range will affect battery performance

OPERATION

Upon failure of the normal utility power the SPS unit is automatically turned on by a solid state switching circuit and provides a minimum of 90 minutes of emergency power to the connected load. Lumen output will be maintained at 100% of the lamp's rating throughout the entire duration. A solid state low voltage disconnect circuit is used to protect the battery from being severely damaged by a deep discharge. When normal utility power is restored, the unit switches the load back to normal utility operation and the fully automatic, temperature compensated, dual mode charger begins to restore the battery; bringing it to full charge within UL 924 specified parameters. A brownout sensing circuit insures proper operation during "low line" conditions.

SYSTEM STATUS MONITORING PANEL

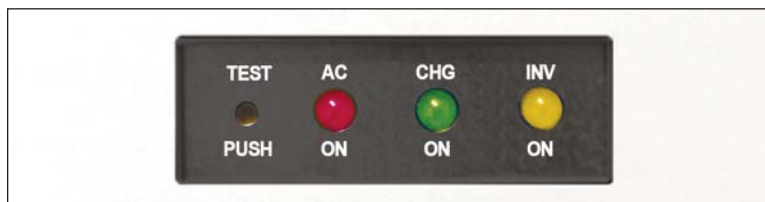

All SPS systems provide a monitoring panel on the front of the unit to show operating status at all times. The panel provides a test switch for user initiated system tests and a 3-LED array that provides an intuitive visual indication of unit readiness.

IMPROVED AESTHETICS

The SPS system's sinusoidal AC output design eliminates voltage drop and proximity concerns. This allows added flexibility in installation location as SPS units can be installed hundreds of feet from the units they power. This means SPS units to be located conveniently out of sight in closets or utility rooms without interrupting architectural aesthetics. In lighting applications, no special or additional emergency fixtures are necessary. Simply designate and connect existing lighting fixtures, either interior or exterior, to the SPS unit for emergency operation eliminating the need for exposed, stand-alone emergency luminaires.

SPS SYSTEM ADVANTAGES

Compared to traditional discrete emergency lighting units, the SPS Series provides emergency illumination from a single power source resulting in lower maintenance overhead and routine testing expenses. SPS units lower installation costs by powering existing lighting fixtures during emergencies. And because connected fixtures are driven at full brilliancy, they provide far superior egress lighting and deliver improved occupant safety.

WARRANTY

Unit: (excluding lamps) 3-years full coverage against defects in materials and workmanship from date of shipment

Battery: 3 years full warranty plus an additional 7 years of pro-rata coverage

WIRING DIAGRAMS

120VAC Connections

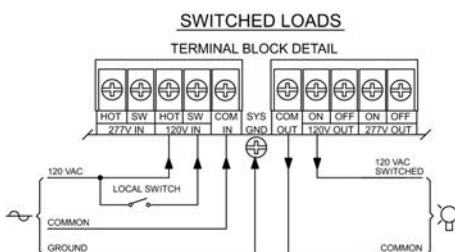
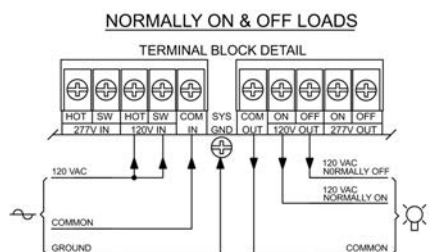
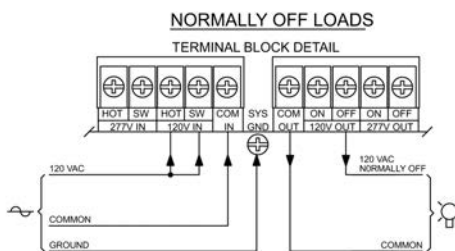
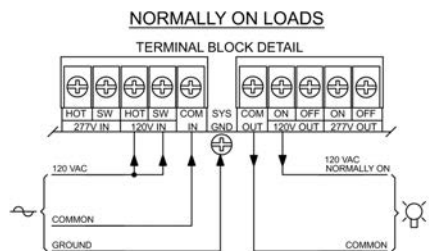

277VAC Connections

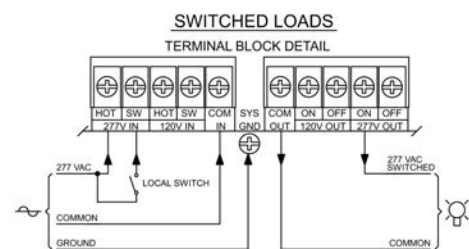
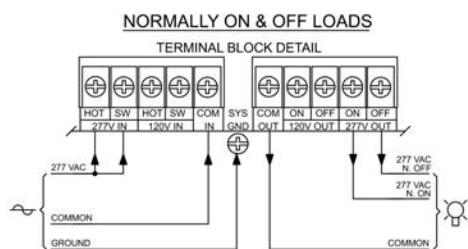
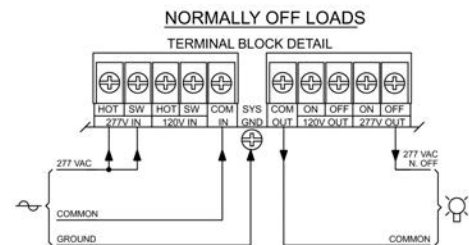
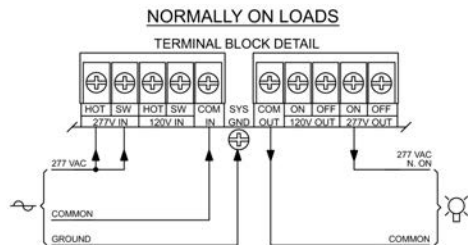

An inverter system with sinusoidal output shall be supplied capable of powering any combination of lighting fixtures, including incandescent, fluorescent, induction and/or LED light sources without compatibility problems.

The system shall transfer in less than 1.0 second to reliably back up lighting fixtures without loss of illumination and operate any and all connected lighting fixtures at full lumen output during the complete 90 minute discharge cycle.

The input voltage shall be the same as the output voltage and shall be single phase (120) (277) volts, 60 Hz. Capacity will be (55 Watts/125VA) (110 Watts/250VA) (220 Watts/250VA) for a minimum duration of 90 minutes.

The design shall be a standby, off-line inverter with on line efficiency of 98%; on-line double conversion UPS systems shall not be considered acceptable alternatives. SPS system output shall be a PWM generated sine wave with less than 3% total harmonic distortion. The system shall also provide short circuit and overload protection as standard.

An intuitive three LED display shall provide system operational information at a glance and alert user to any malfunction in system performance. Authorized maintenance personnel shall have access to the system's controls while being protected from any live exposed connections.

Protective devices shall include AC Line fuses, DC input breaker and a DC input fuse. The entire SPS system, including batteries, shall be incorporated into compact cabinetry which shall have provisions for (surface)(recessed)(T-Grid) mounting.

System shall utilize a sealed lead calcium battery with a 10 year design life. The charger shall be temperature compensated, dual mode type, and recharge the batteries as per UL 924 guidelines. Entire system shall tested, approved, and labeled to UL924 Emergency Lighting and Power Systems standards. (T-Grid models will be plenum rated). System shall be Best SPS series model number: _____